

**INSULATED
ROOF AND WALL
SANDWICH PANELS**

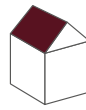

istanbulmavi

INSULATED SANDWICH ROOF PANELS



PUR/PIR Insulated 3 Ribs Roof Panel RP-3S / RI-3S

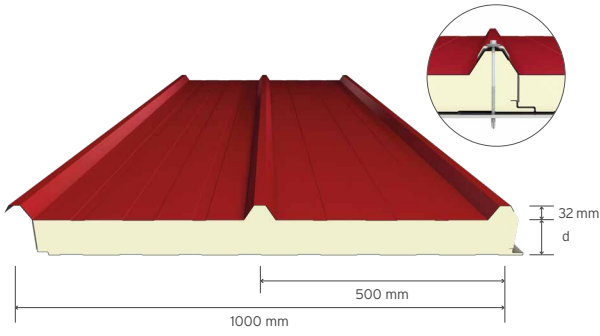

Core Material	PUR PIR
Fire Performance	B-s2; d0 B-s1; d0
Core Thickness = d (mm)	40 50 60 70 75 80 100 120 150 180 200**
Distributed Load* (kg/m²)	169 211 246 277 291 305 355 399 458 509 540
Outer Sheet Thickness (mm)	0,45 - 0,50 - 0,60 - 0,70 - 0,80
Inner Sheet Thickness (mm)	0,35 - 0,40 - 0,45 - 0,50 - 0,60 - 0,70
Place of Production	İzmir, Mersin, Sakarya

Certificates



Usage Areas



* Uniformly distributed load values calculated according to 0,50 mm outer sheet, 0,40 mm inner sheet and 1,50 m multi span.
 ** Production at the Sakarya factory. *** Certificate is valid for PIR insulated panels.

PUR/PIR Insulated 5 Ribs Roof Panel RP-5S / RI-5S

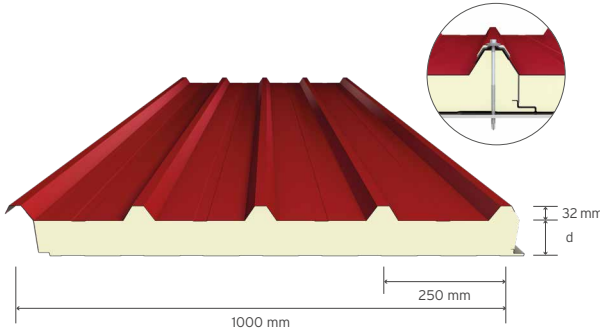

Core Material	PUR PIR
Fire Performance	B-s2; d0 B-s1; d0
Core Thickness = d (mm)	40 50 60 70 75 80 100 120 150 180 200**
Distributed Load* (kg/m²)	241 300 349 391 411 430 498 558 640 712 757
Outer Sheet Thickness (mm)	0,45 - 0,50 - 0,60 - 0,70 - 0,80
Inner Sheet Thickness (mm)	0,35 - 0,40 - 0,45 - 0,50 - 0,60 - 0,70
Place of Production	İzmir, Mersin, Sakarya

Certificates



Usage Areas



* Uniformly distributed load values calculated according to 0,50 mm outer sheet, 0,40 mm inner sheet and 1,50 m multi span.
 ** Production at the Sakarya factory. *** Certificate is valid for PIR insulated panels.

PUR/PIR Insulated 3 Ribs Secret Fix Roof Panel RP-3H / RI-3H

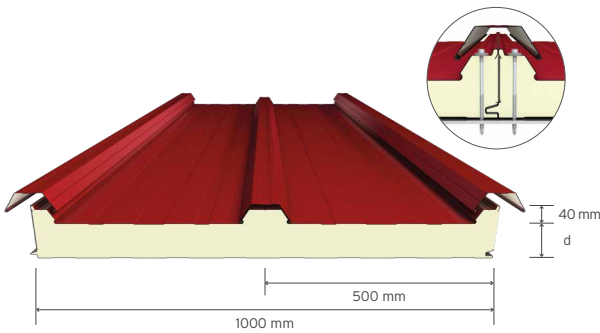

Core Material	PUR PIR
Fire Performance	B-s2; d0 B-s1; d0
Core Thickness = d (mm)	40 50 60 70 75 80 100 120 150 180 200
Distributed Load* (kg/m²)	201 266 318 362 382 400 468 527 606 677 720
Outer Sheet Thickness (mm)	0,45 - 0,50 - 0,60
Inner Sheet Thickness (mm)	0,35 - 0,40 - 0,45 - 0,50 - 0,60
Place of Production	Sakarya

Certificates

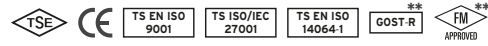

Usage Areas



* Uniformly distributed load values calculated according to 0,50 mm outer sheet, 0,40 mm inner sheet and 1,50 m multi span.
 ** Certificate is valid for PIR insulated panels.

PUR/PIR Insulated 5 Ribs Secret Fix Roof Panel RP-5H / RI-5H

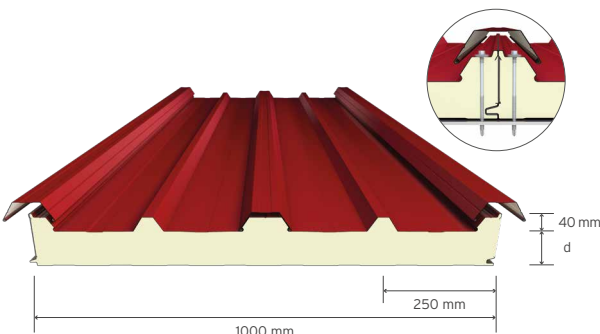

Core Material	PUR PIR
Fire Performance	B-s2; d0 B-s1; d0
Core Thickness = d (mm)	40 50 60 70 75 80 100 120 150 180 200
Distributed Load* (kg/m²)	263 342 405 458 483 505 587 657 736 743 747
Outer Sheet Thickness (mm)	0,45 - 0,50 - 0,60
Inner Sheet Thickness (mm)	0,35 - 0,40 - 0,45 - 0,50 - 0,60
Place of Production	Sakarya

Certificates

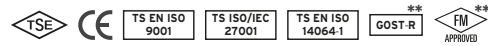

Usage Areas



* Uniformly distributed load values calculated according to 0,50 mm outer sheet, 0,40 mm inner sheet and 1,50 m multi span.
 ** Certificate is valid for PIR insulated panels.

PUR/PIR Insulated 4 Ribs Solar Roof Panel RP-4SS / RI-4SS

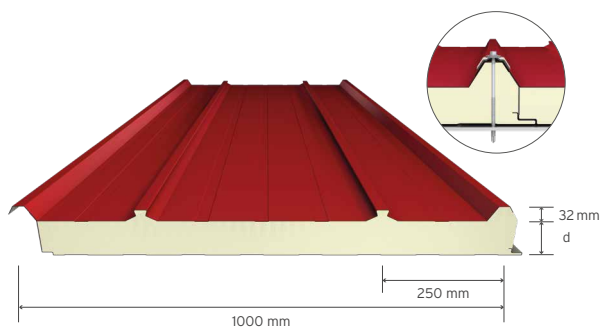

Core Material	PUR PIR
Fire Performance	B-s2; d0 B-s1; d0
Core Thickness = d (mm)	40 50 60
Distributed Load* (kg/m²)	169 211 246
Outer Sheet Thickness (mm)	0,45 - 0,50 - 0,60
Inner Sheet Thickness (mm)	0,35 - 0,40 - 0,45 - 0,50 - 0,60
Place of Production	Mersin

Certificates

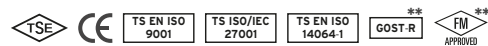

Usage Areas



* Uniformly distributed load values calculated according to 0,50 mm outer sheet, 0,40 mm inner sheet and 1,50 m multi span.
 ** Certificate is valid for PIR insulated panels.

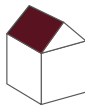



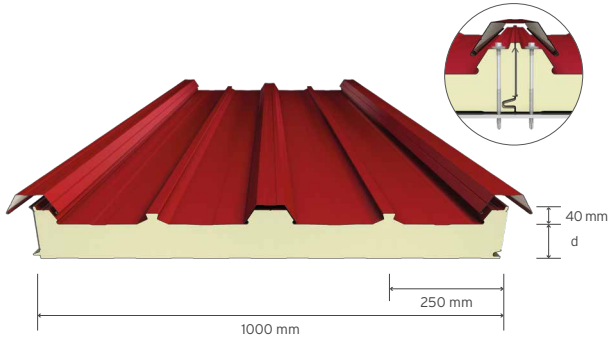

INSULATED SANDWICH ROOF PANELS

PUR/PIR Insulated 5 Ribs Secret Fix Solar Roof Panel RP-5H / RI-5H



Core Material	PUR PIR
Fire Performance	B-s2; d0 B-s1; d0
Core Thickness = d (mm)	40 50 60 70 75 80 100 120 150 180 200
Distributed Load* (kg/m²)	263 342 405 458 483 505 587 657 736 743 747
Outer Sheet Thickness (mm)	0,45 - 0,50 - 0,60
Inner Sheet Thickness (mm)	0,35 - 0,40 - 0,45 - 0,50 - 0,60
Place of Production	Sakarya

Certificates       



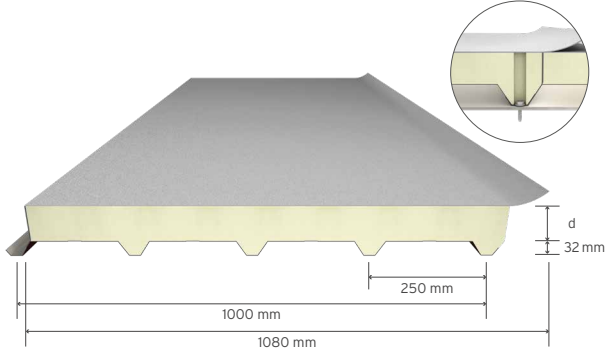

Usage Areas     

* Uniformly distributed load values calculated according to 0,50 mm outer sheet, 0,40 mm inner sheet and 1,50 m multi span.
** Certificate is valid for PIR insulated panels.

PUR/PIR Insulated 5 Ribs Membrane Roof Panel - Single Sheet RP-5SM / RI-5SM



Core Material	PUR PIR
Fire Performance	- BROOF (t2)
Core Thickness = d (mm)	40 - 50 - 60 - 70 - 75 - 80 - 100 - 120 - 150 - 180 - 200 **
Outer Sheet Thickness (mm)	1,20 - 1,50 - 1,80 - 2,00 (PVC or TPO Membrane)
Inner Sheet Thickness (mm)	0,50 0,60 0,70 0,80
Distributed Load* (kg/m²)	131 161 188 214
Place of Production	İzmir, Mersin, Sakarya

Certificates     





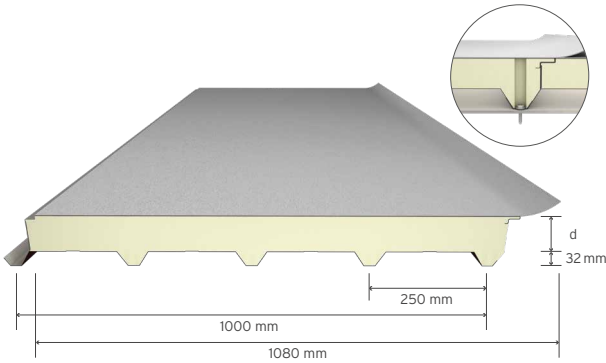

Usage Areas   

* Uniformly distributed load values calculated for all core thickness according to 1,50 m multi span.
** Production at the Sakarya factory. *** Certificate is valid for PIR insulated panels.

PUR/PIR Insulated 5 Ribs Membrane Roof Panel - Double Sheet RP-5SM+ / RI-5SM+



Core Material	PUR PIR
Fire Performance	- BROOF (t2)
Core Thickness = d (mm)	40 - 50 - 60 - 70 - 75 - 80 - 100 - 120 - 150 - 180 - 200*
Membrane Thickness (mm)	1,20 - 1,50 - 1,80 - 2,00 (PVC)
Outer Sheet Thickness (mm)	0,40 - 0,45 - 0,50 - 0,60 - 0,70
Inner Sheet Thickness (mm)	0,50 - 0,60 - 0,70 - 0,80
Place of Production	İzmir, Mersin, Sakarya

Certificates       

Usage Areas   

* Please contact Teknopanel for load table values.
** Production at the Sakarya factory. ** Certificate is valid for PIR insulated panels.

PUR/PIR Insulated 3 Ribs GRP Roof Panel RP-3SC / RI-3SC

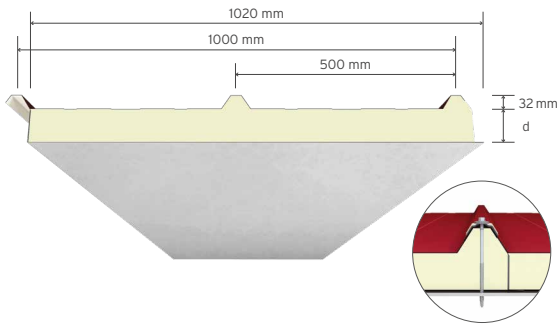

Core Material	PUR - PIR
Core Thickness = d (mm)	40 50 60
Distributed Load* (kg/m²)	98 140 189
Outer Sheet Thickness (mm)	0,45 - 0,50 - 0,60 - 0,70 - 0,80
Inner Sheet Thickness (mm)	0,70 - 1,00 (GRP)
Place of Production	Mersin, Sakarya

Certificates    

Usage Areas  

* Uniformly distributed load values calculated according to 0,50 mm outer sheet, 0,70 mm GRP inner sheet and 1,00 m multi span.
** Certificate is valid for PIR insulated panels.

PUR/PIR Insulated 5 Ribs GRP Roof Panel RP-5SC / RI-5SC

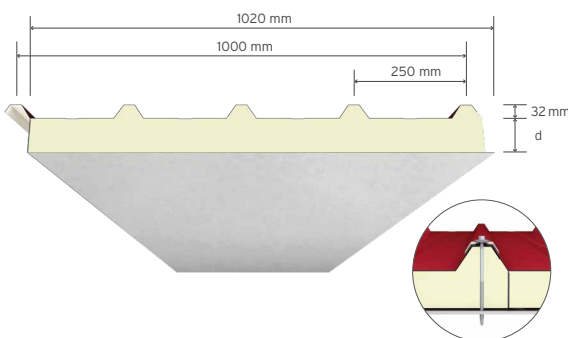

Core Material	PUR - PIR
Core Thickness = d (mm)	40 50 60
Distributed Load* (kg/m²)	100 142 192
Outer Sheet Thickness (mm)	0,45 - 0,50 - 0,60 - 0,70 - 0,80
Inner Sheet Thickness (mm)	0,70 - 1,00 (GRP)
Place of Production	Mersin, Sakarya

Certificates    

Usage Areas  

* Uniformly distributed load values calculated according to 0,50 mm outer sheet, 0,70 mm GRP inner sheet and 1,00 m multi span.
** Certificate is valid for PIR insulated panels.

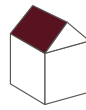

Rock Wool Insulated 5 Ribs Roof Panel RR-5S

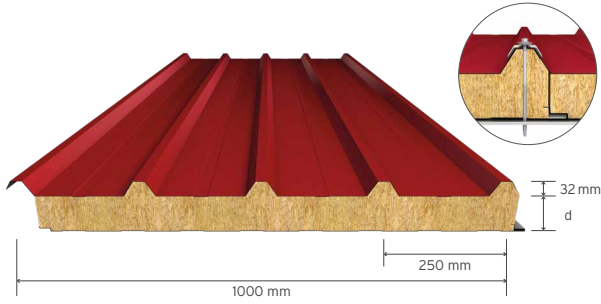

Core Material	Rock Wool
Fire Performance	A2-s1; d0
Core Thickness = d (mm)	50 60 80 100 120 150
Distributed Load* (kg/m²)	313 365 451 525 547 555
Outer Sheet Thickness (mm)	0,50 - 0,60 - 0,70 - 0,80
Inner Sheet Thickness (mm)	0,40 - 0,45 - 0,50 - 0,60 - 0,70
Place of Production	Mersin, Sakarya

Certificates      

Usage Areas    

* Uniformly distributed load values calculated according to 0,50 mm outer sheet, 0,50 mm inner sheet and 1,50 m multi span.

Rock Wool Insulated 5 Ribs Membrane Roof Panel - Single Sheet RR-5SM

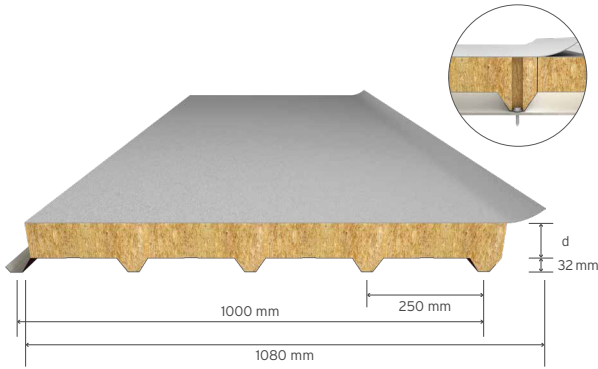

Core Material	Rock Wool
Fire Performance	BROOF (t2)
Core Thickness = d (mm)	50 - 60 - 80 - 100 - 120 - 150
Outer Sheet Thickness (mm)	1,20 - 1,50 - 1,80 - 2,00 (PVC or TPO Membrane)
Inner Sheet Thickness (mm)	0,50 0,60 0,70 0,80
Distributed Load* (kg/m²)	131 161 188 214
Place of Production	Mersin, Sakarya

Certificates    





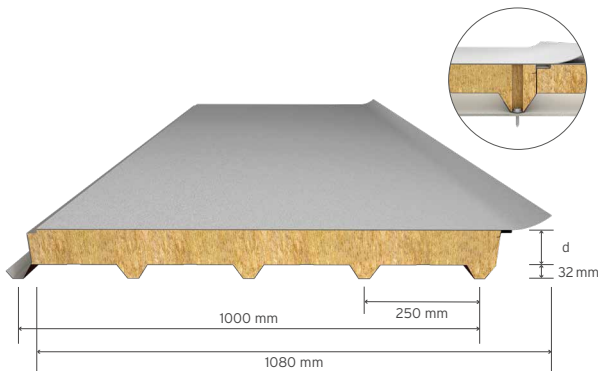

Usage Areas   

* Uniformly distributed load values calculated for all core thickness according to 1,50 m multi span.

Rock Wool Insulated 5 Ribs Membrane Roof Panel - Double Sheet RR-5SM+



Core Material	Rock Wool
Fire Performance	BROOF (t2)
Core Thickness = d (mm)	50 - 60 - 80 - 100 - 120 - 150
Membrane Thickness (mm)	1,20 - 1,50 - 1,80 - 2,00 (PVC)
Outer Sheet Thickness (mm)	0,40 - 0,45 - 0,50 - 0,60 - 0,70
Inner Sheet Thickness (mm)	0,50 - 0,60 - 0,70 - 0,80
Place of Production	Mersin, Sakarya

Certificates      

Usage Areas   

* Please contact İstanbul Mavi for load table values.



INSULATED SANDWICH WALL PANELS

PUR/PIR Insulated Standard Lined Wall Panel WP-SP / WI-SP

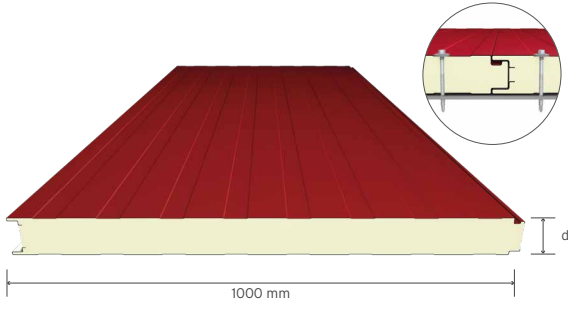

Core Material	PUR PIR
Fire Performance	B-s2; d0 B-s1; d0
Core Thickness = d (mm)	40 50 60 70 75 80 100 120 150 180 200
Distributed Load* (kg/m²)	175 222 271 320 345 370 471 574 732 892 999
Outer Sheet Thickness (mm)	0,45 - 0,50 - 0,60 - 0,70
Inner Sheet Thickness (mm)	0,35 - 0,40 - 0,45 - 0,50 - 0,60 - 0,70
Place of Production	İzmir, Mersin, Sakarya
Certificates	
Usage Areas	

* Uniformly distributed load values calculated according to 0,50 mm outer sheet, 0,40 mm inner sheet and 2,00 m multi span.
** Certificate is valid for PIR insulated panels.

PUR/PIR Insulated Standard Micro Lined Wall Panel WP-SM / WI-SM

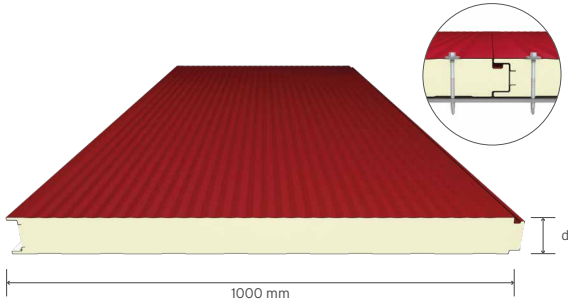

Core Material	PUR PIR
Fire Performance	B-s2; d0 B-s1; d0
Core Thickness = d (mm)	40 50 60 70 75 80 100 120 150 180 200
Distributed Load* (kg/m²)	175 222 271 320 345 370 471 574 732 892 999
Outer Sheet Thickness (mm)	0,45 - 0,50 - 0,60 - 0,70
Inner Sheet Thickness (mm)	0,35 - 0,40 - 0,45 - 0,50 - 0,60 - 0,70
Place of Production	İzmir, Mersin, Sakarya
Certificates	
Usage Areas	

* Uniformly distributed load values calculated according to 0,50 mm outer sheet, 0,40 mm inner sheet and 2,00 m multi span.
** Certificate is valid for PIR insulated panels.

PUR/PIR Insulated Standard Deep Lined Wall Panel WP-SD / WI-SD

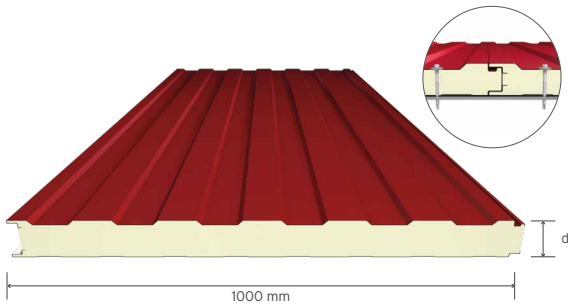

Core Material	PUR PIR
Fire Performance	B-s2; d0 B-s1; d0
Core Thickness = d (mm)	50 60 70 75 80 100 120 150 180 200
Distributed Load* (kg/m²)	222 271 320 345 370 471 574 732 892 999
Outer Sheet Thickness (mm)	0,45 - 0,50 - 0,60 - 0,70
Inner Sheet Thickness (mm)	0,35 - 0,40 - 0,45 - 0,50 - 0,60 - 0,70
Place of Production	İzmir
Certificates	
Usage Areas	

* Uniformly distributed load values calculated according to 0,50 mm outer sheet, 0,40 mm inner sheet and 2,00 m multi span.
** Certificate is valid for PIR insulated panels.

PUR/PIR Insulated Secret Fix Lined Wall Panel WP-HP / WI-HP

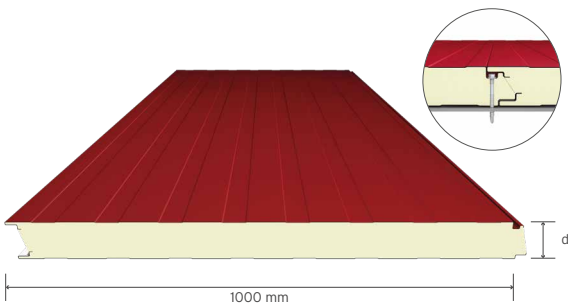

Core Material	PUR PIR
Fire Performance	B-s2; d0 B-s1; d0
Core Thickness = d (mm)	40 50 60 70 75 80 100 120 150 180 200
Distributed Load* (kg/m²)	190 242 294 348 375 402 512 624 795 969 1086
Outer Sheet Thickness (mm)	0,45 - 0,50 - 0,60 - 0,70
Inner Sheet Thickness (mm)	0,35 - 0,40 - 0,45 - 0,50 - 0,60 - 0,70
Place of Production	İzmir, Mersin, Sakarya
Certificates	
Usage Areas	

* Uniformly distributed load values calculated according to 0,50 mm outer sheet, 0,40 mm inner sheet and 2,00 m multi span.
** Certificate is valid for PIR insulated panels.





INSULATED SANDWICH WALL PANELS

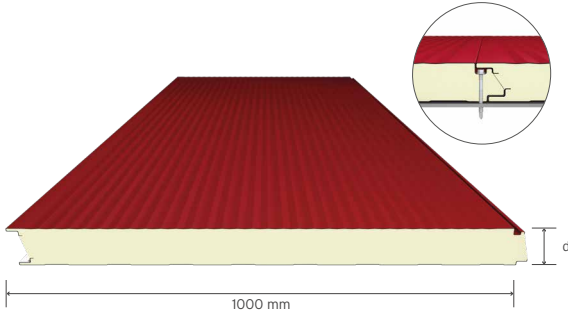





PUR/PIR Insulated Secret Fix Micro Lined Wall Panel WP-HM / WI-HM



Core Material	PUR PIR
Fire Performance	B-s2; d0 B-s1; d0
Core Thickness = d (mm)	40 50 60 70 75 80 100 120 150 180 200
Distributed Load* (kg/m²)	190 242 294 348 375 402 512 624 795 969 1086
Outer Sheet Thickness (mm)	0,45 - 0,50 - 0,60 - 0,70
Inner Sheet Thickness (mm)	0,35 - 0,40 - 0,45 - 0,50 - 0,60 - 0,70
Place of Production	İzmir, Mersin, Sakarya

Certificates        

Usage Areas     

* Uniformly distributed load values calculated according to 0,50 mm outer sheet, 0,40 mm inner sheet and 2,00 m multi span.
** Certificate is valid for PIR insulated panels.

PUR/PIR Insulated Secret Fix Deep Lined Wall Panel WP-HD / WI-HD

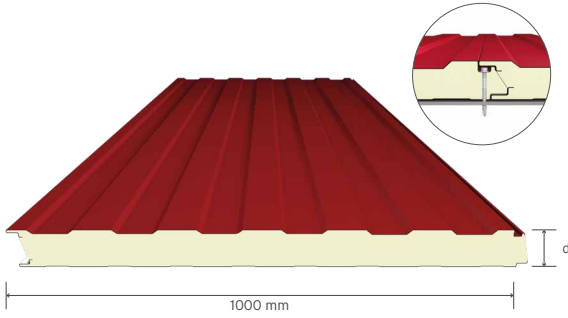

Core Material	PUR PIR
Fire Performance	B-s2; d0 B-s1; d0
Core Thickness = d (mm)	50 60 70 75 80 100 120 150 180 200
Distributed Load* (kg/m²)	242 294 348 375 402 512 624 795 969 1086
Outer Sheet Thickness (mm)	0,45 - 0,50 - 0,60 - 0,70
Inner Sheet Thickness (mm)	0,35 - 0,40 - 0,45 - 0,50 - 0,60 - 0,70
Place of Production	İzmir

Certificates        







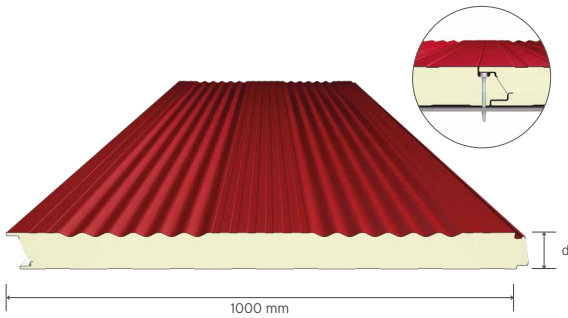

Usage Areas     





* Uniformly distributed load values calculated according to 0,50 mm outer sheet, 0,40 mm inner sheet and 2,00 m multi span.
** Certificate is valid for PIR insulated panels.

PUR/PIR Insulated Secret Fix Sinus & Lined Wall Panel WP-HPS / WI-HPS



Core Material	PUR PIR
Fire Performance	B-s2; d0 B-s1; d0
Core Thickness = d (mm)	40 50 60 70 75 80 100 120 150 180 200
Distributed Load* (kg/m²)	190 242 294 348 375 402 512 624 795 969 1086
Outer Sheet Thickness (mm)	0,45 - 0,50 - 0,60 - 0,70
Inner Sheet Thickness (mm)	0,35 - 0,40 - 0,45 - 0,50 - 0,60 - 0,70
Place of Production	Sakarya

Certificates        

Usage Areas    

* Uniformly distributed load values calculated according to 0,50 mm outer sheet, 0,40 mm inner sheet and 2,00 m multi span.
** Certificate is valid for PIR insulated panels.

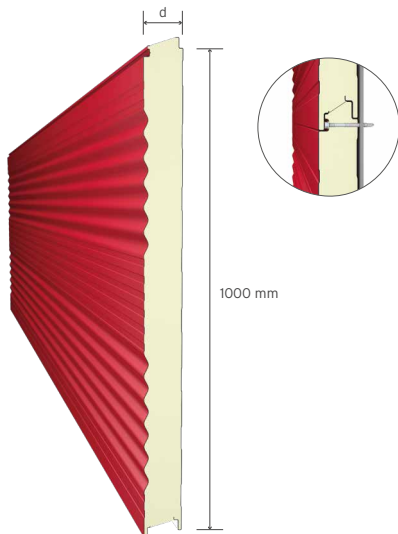



INSULATED SANDWICH WALL PANELS

Rock Wool Insulated Standard Lined Wall Panel WR-SP

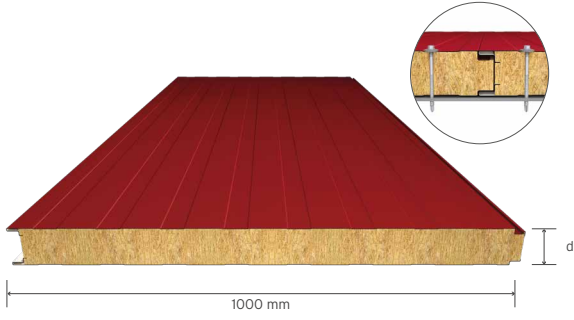

Core Material	Rock Wool
Fire Performance	A2-s1; d0
Core Thickness = d (mm)	50 60 80 100 120 150
Distributed Load* (kg/m²)	156 190 260 333 407 520
Outer Sheet Thickness (mm)	0,50 - 0,60 - 0,70
Inner Sheet Thickness (mm)	0,40 - 0,45 - 0,50 - 0,60 - 0,70
Place of Production	Mersin, Sakarya

Certificates      

Usage Areas    

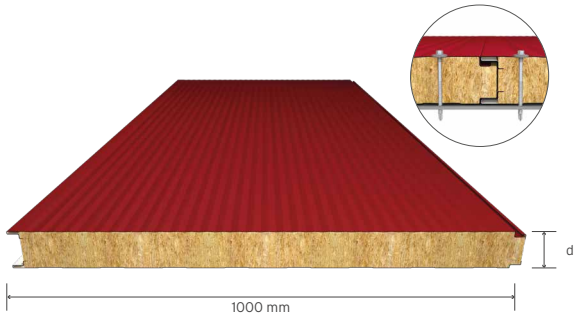

* Uniformly distributed load values calculated according to 0,50 mm outer sheet, 0,50 mm inner sheet and 2,00 m multi span.

Rock Wool Insulated Standard Micro Lined Wall Panel WR-SM



Core Material	Rock Wool
Fire Performance	A2-s1; d0
Core Thickness = d (mm)	50 60 80 100 120 150
Distributed Load* (kg/m²)	156 190 260 333 407 520
Outer Sheet Thickness (mm)	0,50 - 0,60 - 0,70
Inner Sheet Thickness (mm)	0,40 - 0,45 - 0,50 - 0,60 - 0,70
Place of Production	Mersin, Sakarya

Certificates      

Usage Areas    

* Uniformly distributed load values calculated according to 0,50 mm outer sheet, 0,50 mm inner sheet and 2,00 m multi span.

Rock Wool Insulated Secret Fix Lined Wall Panel WR-HP

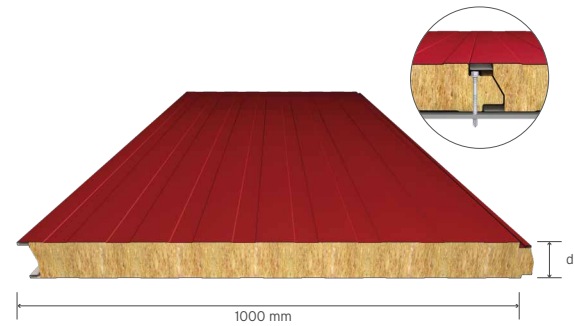

Core Material	Rock Wool
Fire Performance	A2-s1; d0
Core Thickness = d (mm)	50 60 80 100 120 150
Distributed Load* (kg/m²)	169 206 283 361 442 565
Outer Sheet Thickness (mm)	0,50 - 0,60 - 0,70
Inner Sheet Thickness (mm)	0,40 - 0,45 - 0,50 - 0,60 - 0,70
Place of Production	Mersin, Sakarya

Certificates      

Usage Areas    

* Uniformly distributed load values calculated according to 0,50 mm outer sheet, 0,50 mm inner sheet and 2,00 m multi span.

Rock Wool Insulated Secret Fix Micro Lined Wall Panel WR-HM

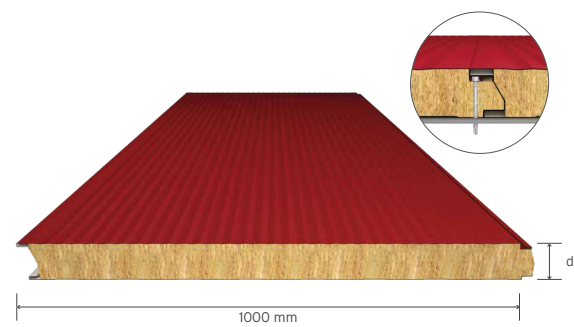

Core Material	Rock Wool
Fire Performance	A2-s1; d0
Core Thickness = d (mm)	50 60 80 100 120 150
Distributed Load* (kg/m²)	169 206 283 361 442 565
Outer Sheet Thickness (mm)	0,50 - 0,60 - 0,70
Inner Sheet Thickness (mm)	0,40 - 0,45 - 0,50 - 0,60 - 0,70
Place of Production	Mersin, Sakarya

Certificates      

Usage Areas    

* Uniformly distributed load values calculated according to 0,50 mm outer sheet, 0,50 mm inner sheet and 2,00 m multi span.

Rock Wool Insulated Secret Fix Sinus & Lined Wall Panel WR-HPS

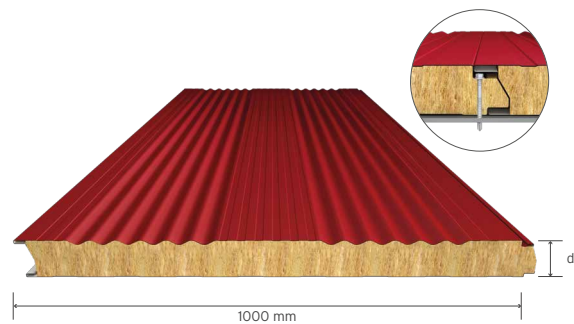

Core Material	Rock Wool
Fire Performance	A2-s1; d0
Core Thickness = d (mm)	50 60 80 100 120 150
Distributed Load* (kg/m²)	169 206 283 361 442 565
Outer Sheet Thickness (mm)	0,50 - 0,60 - 0,70
Inner Sheet Thickness (mm)	0,40 - 0,45 - 0,50 - 0,60 - 0,70
Place of Production	Sakarya

Certificates      

Usage Areas    

* Uniformly distributed load values calculated according to 0,50 mm outer sheet, 0,50 mm inner sheet and 2,00 m multi span.



PUR/PIR Insulated Cold Storage Panel CP-SP / CI-SP

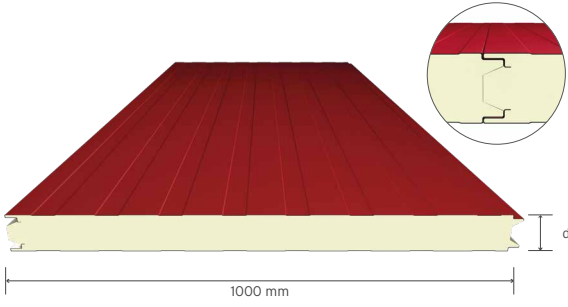

Core Material	PUR PIR
Fire Performance	B-s2; d0 B-s1; d0
Core Thickness = d (mm)	80 - 100 - 120 - 150 - 180 - 200
Outer Sheet Thickness (mm)	0,50 - 0,60 - 0,70
Inner Sheet Thickness (mm)	0,40 - 0,45 - 0,50 - 0,60 - 0,70
Place of Production	İzmir, Mersin

Certificates



Usage Areas



* Certificate is valid for PIR insulated panels.

PUR/PIR Insulated Flat Cold Storage Panel CP-SP Flat / CI-SP Flat

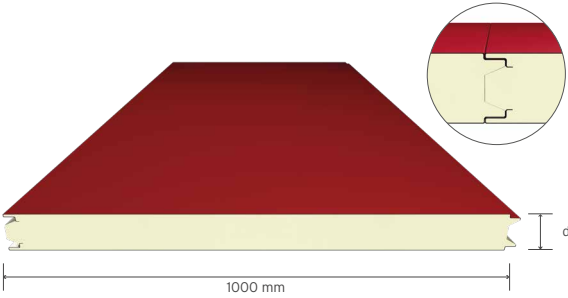

Core Material	PUR PIR
Fire Performance	B-s2; d0 B-s1; d0
Core Thickness = d (mm)	80 - 100 - 120 - 150 - 180 - 200
Outer Sheet Thickness (mm)	0,50 - 0,60 - 0,70
Inner Sheet Thickness (mm)	0,50 - 0,60 - 0,70
Place of Production	İzmir, Mersin

Certificates

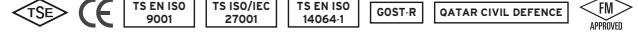

Usage Areas



* Certificate is valid for PIR insulated panels.

PUR/PIR Insulated Cold Storage Panel - Sakarya CP-SS / CI-SS

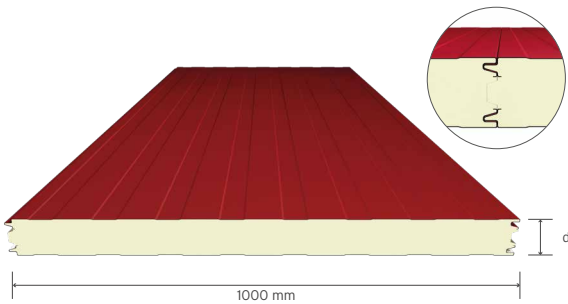

Core Material	PUR PIR
Fire Performance	B-s2; d0 B-s1; d0
Core Thickness = d (mm)	80 - 100 - 120 - 150 - 180 - 200
Outer Sheet Thickness (mm)	0,50 - 0,60 - 0,70
Inner Sheet Thickness (mm)	0,40 - 0,45 - 0,50 - 0,60 - 0,70
Place of Production	Sakarya

Certificates

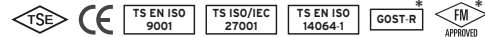

Usage Areas



* Certificate is valid for PIR insulated panels.

PUR/PIR Insulated Flat Cold Storage Panel - Sakarya CP-SS Flat / CI-SS Flat

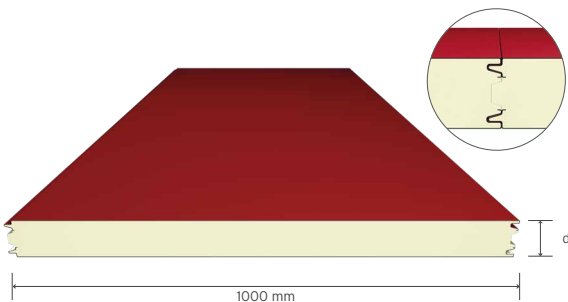

Core Material	PUR PIR
Fire Performance	B-s2; d0 B-s1; d0
Core Thickness = d (mm)	80 - 100 - 120 - 150 - 180 - 200
Outer Sheet Thickness (mm)	0,50 - 0,60 - 0,70
Inner Sheet Thickness (mm)	0,50 - 0,60 - 0,70
Place of Production	Sakarya

Certificates

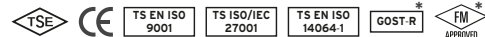

Usage Areas









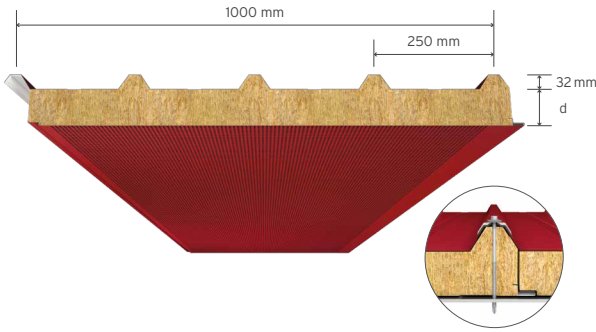

* Certificate is valid for PIR insulated panels.



INSULATED ACOUSTIC SANDWICH PANELS







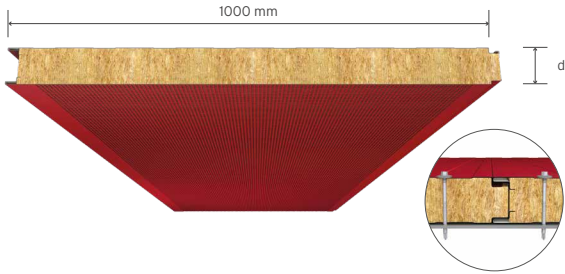

Rock Wool Insulated 5 Ribs Acoustic Roof Panel RR-5SK



Core Material	Rock Wool
Core Thickness = d (mm)	50 60 80 100 120 150
Sound Reduction Value - R_w dB (500Hz)	~34
Sound Absorption Coefficient - α_w (500Hz)	~0,85
Outer Sheet Thickness (mm)	0,50 - 0,60 - 0,70 - 0,80
Inner Sheet Thickness (mm)	0,50 - 0,60
Place of Production	Mersin, Sakarya
Certificates	   
Usage Areas	   







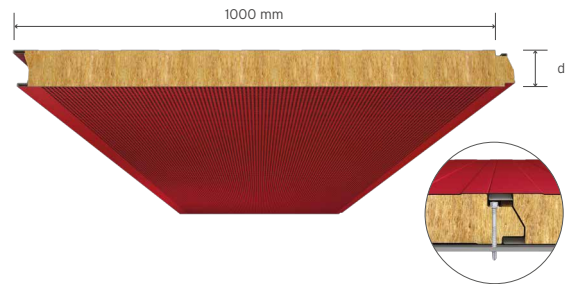

Rock Wool Insulated Acoustic Standard Wall Panel WR-SK



Core Material	Rock Wool
Core Thickness = d (mm)	50 60 80 100 120 150
Sound Reduction Value - R_w dB (500Hz)	~34
Sound Absorption Coefficient - α_w (500Hz)	~0,85
Outer Sheet Thickness (mm)	0,50 - 0,60 - 0,70
Inner Sheet Thickness (mm)	0,50 - 0,60
Place of Production	Mersin, Sakarya
Certificates	   
Usage Areas	   

Rock Wool Insulated Acoustic Secret Fix Wall Panel WR-HK









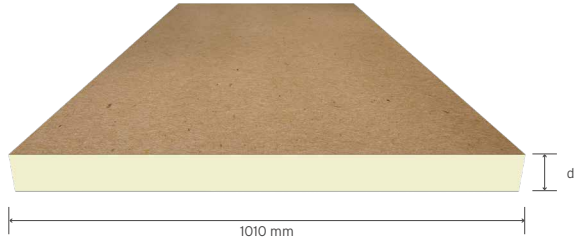

Core Material	Rock Wool
Core Thickness = d (mm)	50 60 80 100 120 150
Sound Reduction Value - R_w dB (500Hz)	~34
Sound Absorption Coefficient - α_w (500Hz)	~0,85
Outer Sheet Thickness (mm)	0,50 - 0,60 - 0,70
Inner Sheet Thickness (mm)	0,50 - 0,60
Place of Production	Mersin, Sakarya
Certificates	   
Usage Areas	   

TEKNOBOARD THERMAL INSULATION BOARD



PUR/PIR Insulated Thermal Insulation Board BP-PP / BI-PP









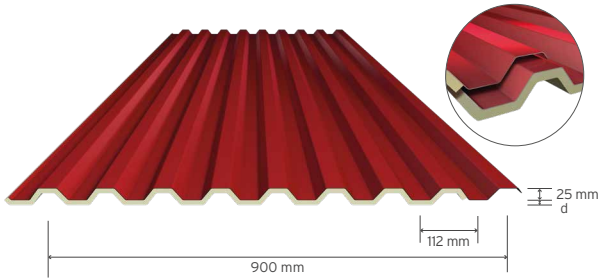

Core Material	PUR PIR
Density (kg/m³)	38 (±2) 40 (±2)
Thermal Conductivity Coefficient (W/mK)	0,028
Core Thickness = d (mm)	30 - 40 - 50 - 60 - 80 - 100
Lower and Upper Surface	Natural Kraft Paper, Aluminum Foil, PVC Membrane
Place of Production	Mersin, Sakarya
Certificates	    
Usage Areas	  

ISOTRAPEZ SINGLE SHEET PANEL



PUR Insulated 9 Ribs Single Sheet Panel RP-9T









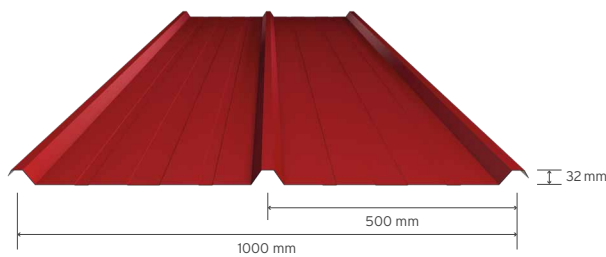

Core Material	PUR
Core Thickness = d (mm)	15
Outer Sheet Metal Type	Prepainted Galvanized Steel
Outer Sheet Thickness (mm)	0,35 - 0,40 - 0,50 - 0,60 - 0,70
Inner Sheet	Polyethylene Film, Aluminum Foil
Place of Production	İzmir
Certificates	  
Usage Areas	    

TRAPEZOIDAL SHEETS









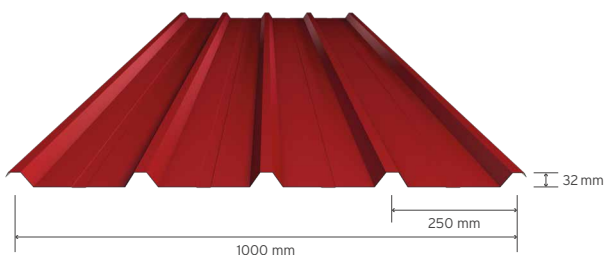

3 Ribs Roof Panel Profiled Trapezoidal Sheet TKT-03



Metal Type	Prepainted Galvanized Steel
Metal Thickness (mm)	0,40 - 0,50 - 0,60 - 0,70 - 0,80
Place of Production	İzmir, Mersin, Sakarya
Certificates	  
Usage Areas	    

5 Ribs Roof Panel Profiled Trapezoidal Sheet TKT-05



Metal Type	Prepainted Galvanized Steel
Metal Thickness (mm)	0,40 - 0,50 - 0,60 - 0,70 - 0,80
Place of Production	İzmir, Mersin, Sakarya
Certificates	  
Usage Areas	    



Roof Flashings

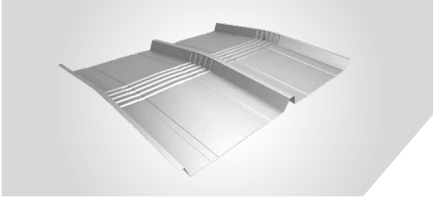

Radius Ridge Capping - 3 Ribs

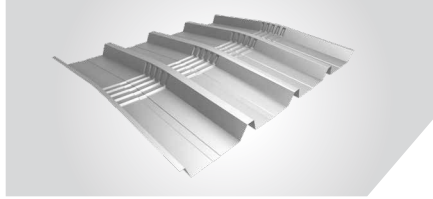

Radius Ridge Capping - 5 Ribs

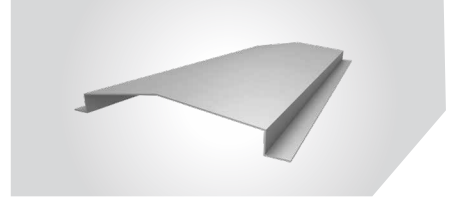

Ridge

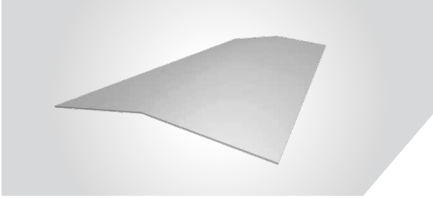

Inside Ridge

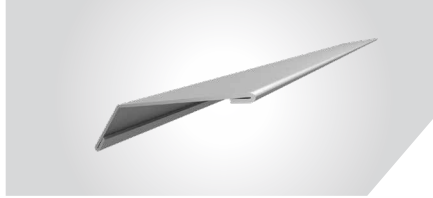

Eave Drip

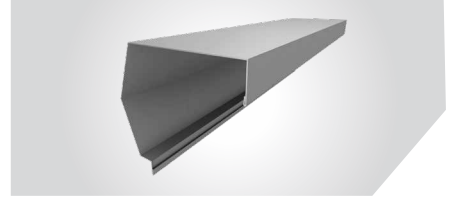

Gable Verge

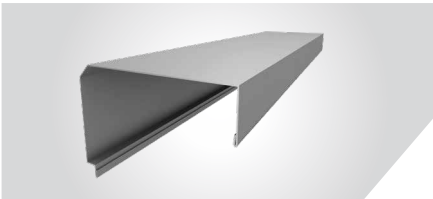

Parapet Capping

Wall Flashings

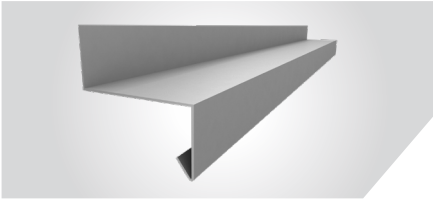

Drip

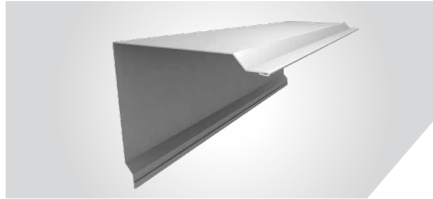

Outer Corner

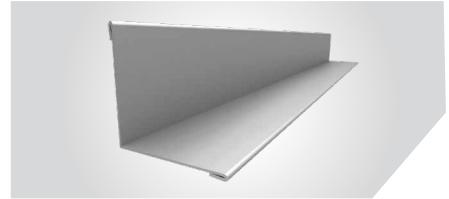

Inner Corner

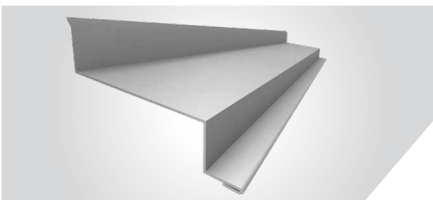

Wall Connector

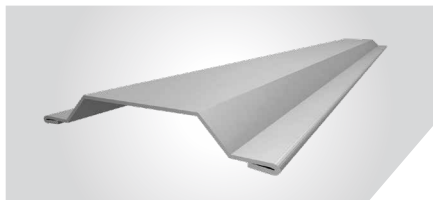

Vertical Junction

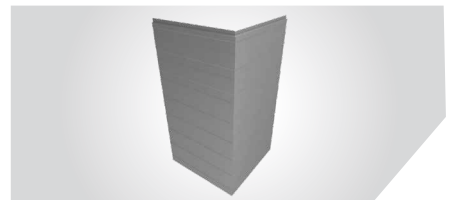

Corner Panel

Cold Storage Flashings

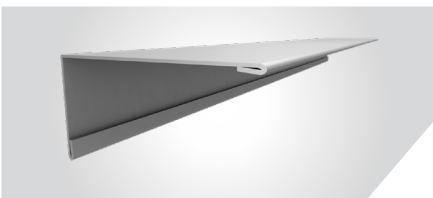

Cold Storage Outer Corner

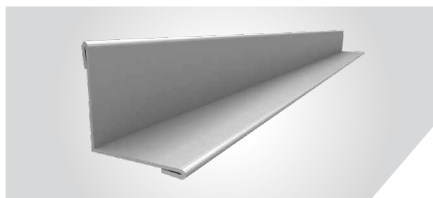

Cold Storage Inner Corner

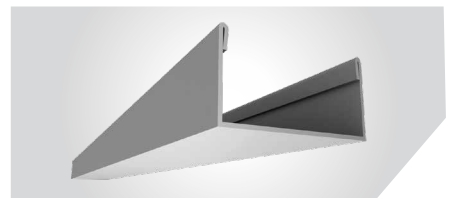

Cold Storage Floor U



İstanbul Mavi Endüstriyel Yapı

Esentepe Mah. Şehit Mehmet Mikdat Ulu ünlü Sk. No:17 Plaza 21 D:3 Şişli / İstanbul

www.istanbulmavi.com.tr

info@istanbulmavi.com.tr

[+90 212 213 62 84](tel:+902122136284)